

DIE PROGRESSION DIRECTION

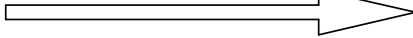

TO CRIMPING TOOL

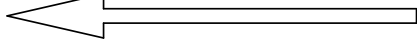

NOTES:

- 1) TERMINAL TO CRIMP WITH AWG#26 WIRE (UL1061 IS RECOMMENDED).
- 2) TERMINAL TO USE HOUSING P/N 87439-***0*.
- 3) REFER CRIMP SPECIFICATION CS-87421.
- 4) REFER PRODUCT SPECIFICATION PS-87437.

PART #	FINISH
87421-0000	2.5µM TIN
87421-0002	GOLD FLASH (SELECTIVE) OVER 1.0 µM NICKEL OVERALL

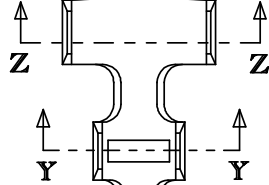
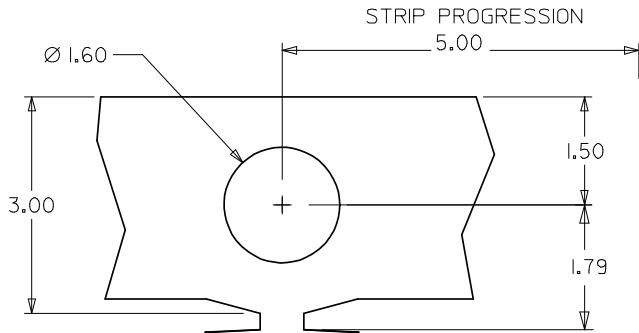

MIN GOLD FLASH
PLATING LENGTH

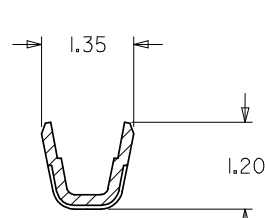
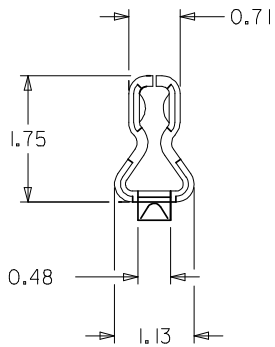

SECT. Y-Y

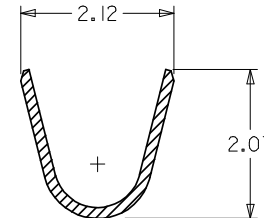

SECT. Z-Z

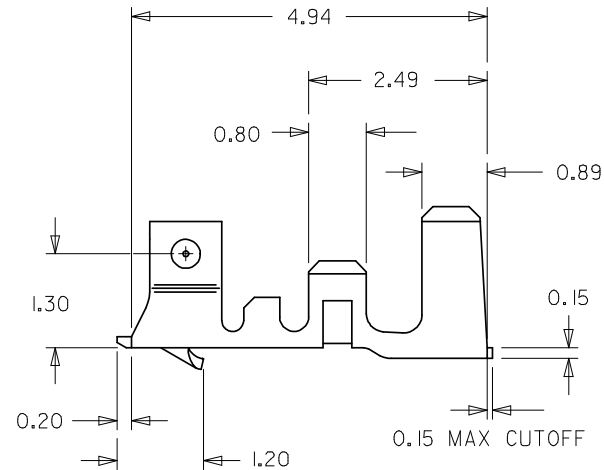

REVISED EC NO: J2008-3226 DRAWN: SLEE 2008/03/24 CHKD: NIKITA 2008/04/09 APPR: SLEE 2008/04/09	QUALITY SYMBOLS	SEE TABLE	NTS MM ONLY	SCALE	DESIGN UNITS METRIC	THIRD ANGLE PROJECTION															
	▽=0 ▽=0	<table border="1"> <tr> <th></th> <th>mm</th> <th>INCH</th> </tr> <tr> <td>4 PLACES</td> <td>±---</td> <td>±---</td> </tr> <tr> <td>3 PLACES</td> <td>±---</td> <td>±---</td> </tr> <tr> <td>2 PLACES</td> <td>±0.20</td> <td>±---</td> </tr> <tr> <td>1 PLACE</td> <td>±---</td> <td>±---</td> </tr> </table>		mm	INCH	4 PLACES	±---	±---	3 PLACES	±---	±---	2 PLACES	±0.20	±---	1 PLACE	±---	±---	DRAWN BY: SKANG DATE: 2007/07/18 CHECKED BY: ATSEE DATE: 2007/07/25 APPROVED BY: MLONG DATE: 2007/07/25	TITLE	1.50MM PITCH CRIMP	
		mm	INCH																		
	4 PLACES	±---	±---																		
3 PLACES	±---	±---																			
2 PLACES	±0.20	±---																			
1 PLACE	±---	±---																			
ANGULAR ± 3° DRAFT WHERE APPLICABLE MUST REMAIN WITHIN DIMENSIONS	MATERIAL NO. SEE TABLE	MOLEX INCORPORATED DOCUMENT NO. SD-87421-0000	SHEET NO. 1 OF 1																		
		SIZE A2	THIS DRAWING CONTAINS INFORMATION THAT IS PROPRIETARY TO MOLEX INCORPORATED AND SHOULD NOT BE USED WITHOUT WRITTEN PERMISSION																		